

Varenummer: 438000200

Beskrivelse: Rota-fix spændelement SD 200

Mål

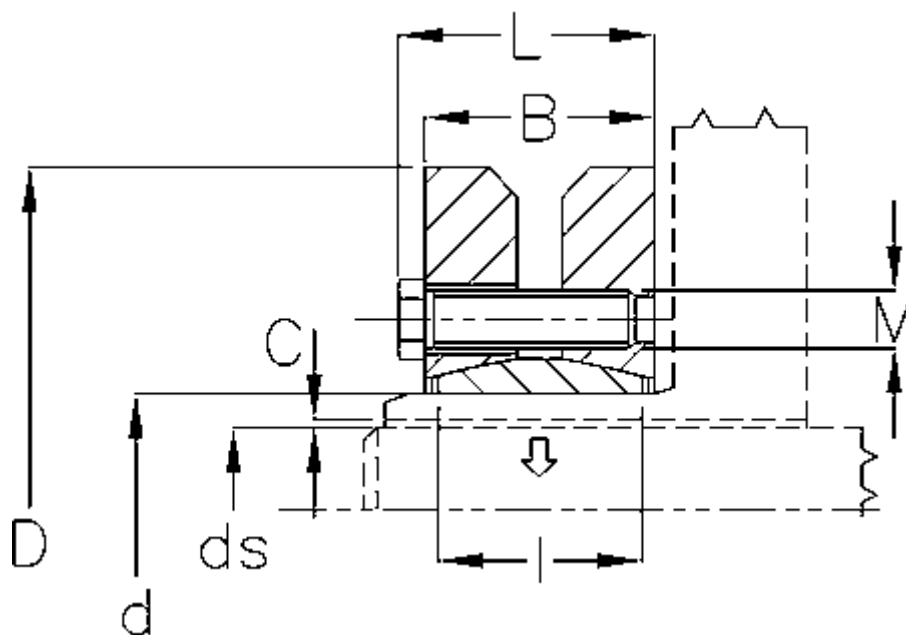

B mm	= 86
C maks.	= 0,090
d H8 mm	= 200
D mm	= 350
ds mm	= 150
F kN aksialkraft	= 980
L mm	= 96
l mm	= 71

M mm	= M16
T Nm drejningsmoment	= 73700
Ts Nm boltetilspændingsmoment	= 250